



EXTROL[®]

ASME Commercial Expansion Tanks



For Closed Hydronic Heating & Chilled Water Systems



EXTROL®

Amtrol hydronic expansion tanks are for use in closed, non-potable hydronic heating and chilled water systems. Available in diaphragm, full acceptance and partial acceptance bladder designs, all Extrol expansion tanks are made in the USA at our ISO 9001: 2008 registered facilities. ASME tanks meet all Section VIII, Division I standards.



EXTROL AX Series

- Diaphragm design; industry's thickest.
- Horizontal and vertical models are available with optional restraints.
- Factory pre-charge: 12 psig.
- Maximum operating temperature: 240° F.

Typical Installation

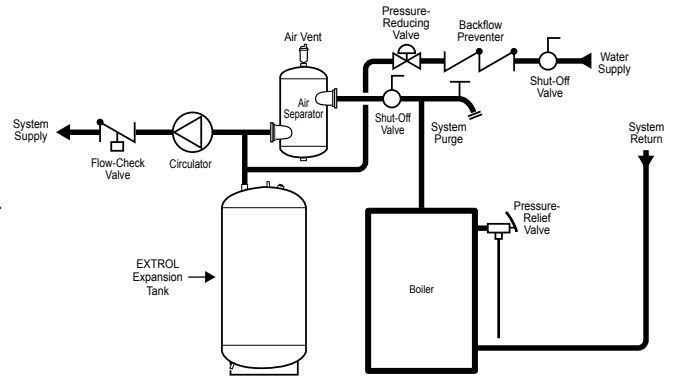

How to Order: Specify Item & Options

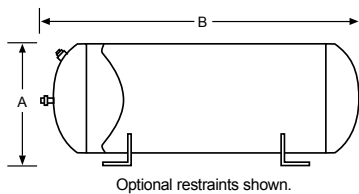
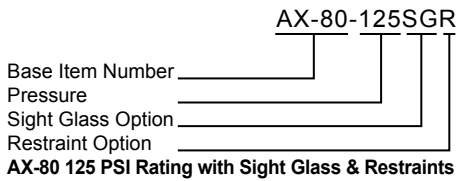

AX Horizontal Series Specifications

Model Number	Tank Volume (Gallons)	Max. Accept. Volume (Gallons)	A Diameter (Inches)	B Length (Inches)	System Conn. ¹ (Inches)	Shipping Weight (lbs.) Max. Working Pressure				
						125 PSI	150 PSI	175 PSI	250 PSI	300 PSI
AX-15	8.0	2.4	12	19	1/2	37	39	48	55	59
AX-20	10.9	2.4	12	26	1/2	46	48	60	69	74
AX-40	21.7	11.3	16	29	1/2	74	76	96	111	118
AX-60	33.6	11.3	16	43	1/2	96	120	125	144	154
AX-80	44.4	22.6	24	29	1	153	160	200	230	245
AX-100	55.7	22.6	24	33	1	174	180	227	261	279
AX-120	68.0	34.0	24	41	1	204	245	266	306	327
AX-144	77.0	34.0	24	46	1	218	250	285	327	350
AX-180	90.0	34.0	24	54	1	232	265	301	348	372
AX-200	110.0	34.0	24	64	1	269	320	350	404	430
AX-240	132.0	46.0	30	51	1	401	403	522	602	642
AX-260	159.0	56.0	30	62	1 1/4	455	460	572	683	728
AX-280	211.0	84.0	30	80	1 1/4	580	600	755	870	930

¹AX-15 through AX-100: Malleable Iron NPTF System Connection. Location: Center.
 AX-120 through AX-240: Malleable Iron NPTM System Connection. Location: Center.
 AX-260 and AX-280: Malleable Iron NPTM System Connection. Location: Top Offset.

How to Order: Specify Item & Options

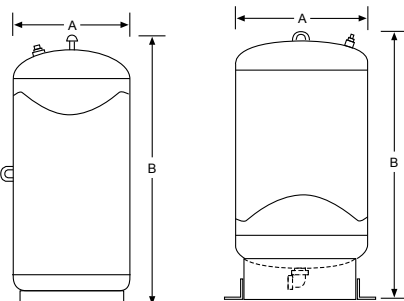
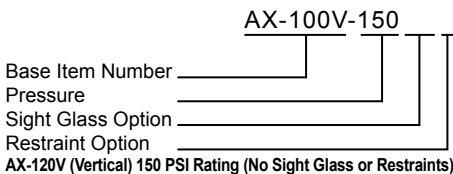

AX-15V through AX-100V
AX-260V and AX-280V

AX-120V through AX-240V
Optional restraints shown.

AX Vertical Series Specifications

Model Number	Tank Volume (Gallons)	Max. Accept. Volume (Gallons)	A Diameter (Inches)	B Height (Inches)	System Conn. ² (Inches)	Shipping Weight (lbs.) Max. Working Pressure				
						125 PSI	150 PSI	175 PSI	250 PSI	300 PSI
AX-15V	8.0	2.4	12	20	1/2	39	41	49	59	62
AX-20V	10.9	2.4	12	27	1/2	47	49	61	71	75
AX-40V	21.7	11.3	16	30	1/2	76	80	99	114	122
AX-60V	33.6	11.3	16	45	1/2	98	103	127	147	157
AX-80V	44.4	22.6	24	29	1	155	167	201	233	248
AX-100V	55.7	22.6	24	34	1	176	187	229	264	282
AX-120V	68.0	34.0	24	47	1	214	255	278	321	342
AX-144V	77.0	34.0	24	52	1	230	267	299	345	368
AX-180V	90.0	34.0	24	60	1	271	275	352	407	434
AX-200V	110.0	34.0	24	66	1	290	358	377	435	464
AX-240V	132.0	46.0	30	58	1	401	403	521	602	642
AX-260V	159.0	56.0	30	65	1 1/4	460	467	598	690	736
AX-280V	211.0	84.0	30	82	1 1/4	590	605	767	885	945

²AX-15V through AX-100V: Malleable Iron NPTF System Connection. Location: Top Center.
 AX-120V through AX-240V: Malleable Iron NPTF System Connection. Location: Bottom.
 AX-260V and AX-280V: Malleable Iron NPTM System Connection. Location: Top Offset.

ASME Commercial Expansion Tanks



EXTROL L Series

- Replaceable, full acceptance bladder design.
- Heavy duty butyl bladder; industry's thickest.
- Free-standing on integral welded ring base.
- Factory pre-charge: 12 psig.
- Maximum operating temperature: 240° F.

How to Order: Specify Item & Options

800-L-175-SGR

Base Item Number _____
 Pressure _____
 Sight Glass Option _____
 Restraint Option _____

800-L 175 PSI Rating with Sight Glass & Restraints

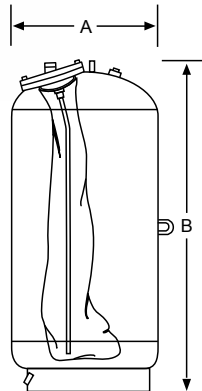

L Series Specifications

Model Number	Tank Volume (Gallons)	Max. Accept. Volume (Gallons)	A Diameter (Inches)	B Height (Inches)	System Conn. ¹ NPTF (Inches)	Shipping Weight (lbs.) Max. Working Pressure				
						125 PSI	150 PSI	175 PSI	250 PSI	300 PSI
200-L	53	53	24	38	1	190	205	250	290	297
300-L	80	80	24	52	1	230	292	320	385	372
400-L	106	106	24	66	1	275	343	375	465	595
500-L	132	132	24	79	1	311	372	435	545	750
600-L	158	158	30	64	1½	439	510	595	720	810
800-L	211	211	30	82	1½	543	565	620	905	950
1000-L	264	264	36	74	1½	609	750	750	1,015	1,065
1200-L	317	317	36	86	1½	700	860	860	1,175	1,235
1400-L	370	370	36	98	1½	783	970	970	1,335	1,400
1600-L	422	422	48	69	1½	1,106	1,425	1,615	1,916	2,015
2000-L	528	528	48	84	1½	1,284	1,675	2,386	2,410	2,651
2500-L	660	660	48	101	2	1,544	1,945	2,411	2,585	2,715
3000-L	792	792	48	118	2	1,719	2,225	2,500	2,950	3,100
3500-L	925	925	54	111	2	2,187	2,375	2,620	3,660	3,780
4000-L	1,057	1,057	54	125	2	2,352	2,640	3,000	4,080	4,285
5000-L	1,321	1,321	60	128	2	2,450	3,740	4,100	4,200	5,200
7500-L	1,980	1,980	72	127	3	4,000	4,300	4,500	5,550	6,750
10000-L	2,640	2,640	72	159	3	4,900	5,300	5,500	6,800	11,000
15000-L	3,963	3,963	72	233	3	6,000	7,600	7,900	9,800	12,500

¹Malleable Iron System Connection.



EXTROL LBC Series

- Replaceable, partial acceptance bladder design.
- Heavy duty butyl bladder; industry's thickest.
- Free-standing on integral welded ring base.
- Factory pre-charge: 12 psig.
- Maximum operating temperature: 240° F.

How to Order: Specify Item & Options

130-LBC-125 R

Base Item Number _____
 Pressure _____
 Sight Glass Option _____
 Restraint Option _____

130-LBC 125 PSI Rating with Restraints (No Sight Glass)

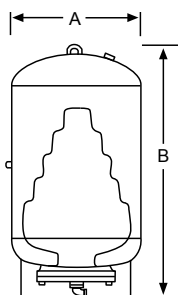

LBC Series Specifications

Model Number	Tank Volume (Gallons)	Max. Accept. Volume (Gallons)	A Diameter (Inches)	B Height (Inches)	System Conn. ¹ NPTF (Inches)	Shipping Weight (lbs.) Max. Working Pressure				
						125 PSI	150 PSI	175 PSI	250 PSI	300 PSI
35-LBC	10	10	10	37	1	67	76	80	94	100
50-LBC	13	11	12	37	1	76	78	91	106	114
85-LBC	22	11	16	35	1	92	95	110	129	138
100-LBC	26	11	16	39	1	99	102	119	138	150
130-LBC	34	27	20	35	1	135	140	162	189	202
165-LBC	44	27	20	40	1	149	153	178	214	225
200-LBC	53	27	24	41	1	195	205	234	273	293
300-LBC	80	27	24	56	1	233	254	280	326	350
400-LBC	106	53	24	69	1	274	308	329	383	411
500-LBC	132	53	24	83	1	310	352	372	434	465
600-LBC	158	53	30	67	1	438	442	525	613	657

¹Malleable Iron System Connection.



EXTROL® Sizing Guide

Things You Must Know:

1. Total System Volume _____ gallons
2. Minimum System Temperature _____ °F
3. Maximum System Temperature _____ °F
4. Minimum Operating Pressure at Expansion Tank . . _____ psig
5. Maximum Operating Pressure at Expansion Tank . _____ psig

Selection of Expansion Tank:

6. Find and enter "Water Expansion Factor" _____ (see Table 1)
7. Amount of Expanded Water = Line (1) x Line (6) . . _____ gallons
8. Find and enter "Tank Acceptance Factor" _____ (see Table 2)
9. Minimum Volume = Line (7) ÷ Line (8) _____ gallons
10. Select an Expansion Tank that is at least equal to Line (9) for Tank Volume (gallons) and Line (7) for Max. Acceptance Volume (gallons). Multiple tanks may be required.

Table 1: Water Expansion Factor

Maximum System Temp.	Minimum System Temperature						
	40° F	50° F	60° F	70° F	80° F	90° F	100° F
60° F	.0005	.0049	—	—	—	—	—
70° F	.0015	.0014	.0009	—	—	—	—
80° F	.0026	.0025	.0020	.0011	—	—	—
90° F	.0041	.0040	.0035	.0026	.0015	—	—
100° F	.0058	.0057	.0052	.0043	.0031	.0017	—
110° F	.0077	.0077	.0072	.0062	.0051	.0037	.0019
120° F	.0100	.0099	.0095	.0086	.0074	.0060	.0043
130° F	.0124	.0123	.0118	.0109	.0098	.0083	.0066
140° F	.0150	.0149	.0145	.0135	.0124	.0110	.0093
150° F	.0179	.0178	.0173	.0164	.0153	.0133	.0121
160° F	.0209	.0208	.0204	.0194	.0181	.0165	.0148
170° F	.0242	.0241	.0236	.0227	.0216	.0201	.0184
180° F	.0276	.0275	.0271	.0261	.0250	.0236	.0219
190° F	.0313	.0312	.0307	.0298	.0287	.0272	.0255
200° F	.0351	.0350	.0346	.0336	.0325	.0311	.0294
210° F	.0391	.0390	.0386	.0376	.0365	.0351	.0334
220° F	.0434	.0433	.0428	.0419	.0408	.0393	.0376
230° F	.0476	.0475	.0471	.0461	.0450	.0436	.0419
240° F	.0522	.0521	.0517	.0507	.0496	.0482	.0465

For fluid applications other than water, consult AMTROL technical services.

Table 2: Tank Acceptance Factor

Maximum Operating Pressure (psig)	Minimum Operating Pressure at Tank (psig)										
	5	10	12	15	20	30	40	50	60	70	80
27	0.527	0.408	0.360	0.288	0.168	—	—	—	—	—	—
30	0.560	0.447	0.403	0.336	0.224	—	—	—	—	—	—
35	0.604	0.503	0.463	0.403	0.302	0.101	—	—	—	—	—
40	0.640	0.548	0.512	0.457	0.366	0.183	—	—	—	—	—
45	0.670	0.586	0.553	0.503	0.419	0.251	0.084	—	—	—	—
50	0.696	0.618	0.587	0.541	0.464	0.309	0.155	—	—	—	—
55	0.717	0.646	0.617	0.574	0.502	0.359	0.215	0.072	—	—	—
60	0.736	0.669	0.643	0.602	0.536	0.402	0.268	0.134	—	—	—
65	0.753	0.690	0.665	0.627	0.565	0.439	0.314	0.188	0.062	—	—
70	0.767	0.708	0.685	0.649	0.590	0.472	0.354	0.236	0.118	—	—
75	0.780	0.725	0.702	0.669	0.613	0.502	0.390	0.279	0.167	0.056	—
80	0.792	0.739	0.718	0.686	0.634	0.528	0.422	0.317	0.211	0.106	—
90	0.812	0.764	0.745	0.716	0.669	0.573	0.478	0.382	0.287	0.191	0.096
100	0.828	0.785	0.767	0.741	0.698	0.610	0.523	0.436	0.347	0.261	0.174
110	0.842	0.802	0.786	0.762	0.723	0.642	0.561	0.481	0.401	0.321	0.240

Acceptance factors based on expansion tank charged to minimum operating pressure while empty of liquid.



Non-ASME & Residential Models can be found in catalog MC 2680.



1400 Division Road, West Warwick, RI USA 02893
 T: 800.426.8765 F: 800.293.1519
www.amtrol.com

